



## ADZL 系列

### 滑軌型平行機械夾爪(加長行程)



#### 產品特性

- 活塞連桿一體式
- 內置式感應磁石
- 滾柱型線軌

#### 產品規格

型號	ADZL-10	ADZL-16	ADZL-20	ADZL-25
項目 \ 缸徑 mm	ø10	ø16	ø20	ø25
作動形式	複動型			
使用流體	空氣			
使用壓力範圍 kgf/cm <sup>2</sup> (kPa)	2~7 (200~700)	1.5~7 (150~700)		
使用溫度範圍 °C	0~60			
最高作動頻度 次/min	100			
給油	無給油			
爪片開合精度 mm	±0.01			
爪片開合行程 mm	8	12	18	22
磁石裝置	附磁石			
重量 kg	0.06	0.14	0.27	0.49

#### 訂購代號

ADZL-16-AMS-L  
①    ②

代號	缸徑 mm
10	ø10
16	ø16
20	ø20
25	ø25

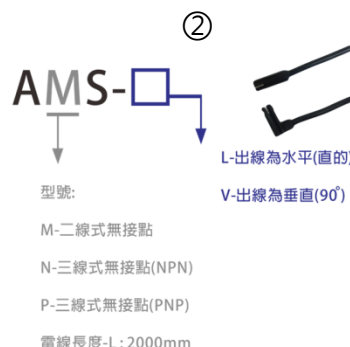



## 外徑夾持力特性圖

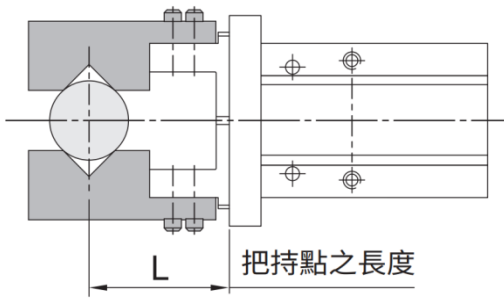

### ADZL-10

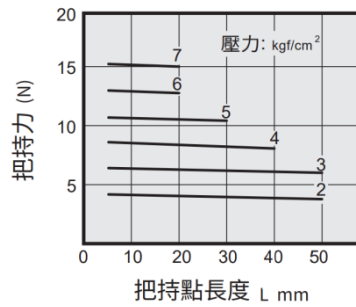

### ADZL-16

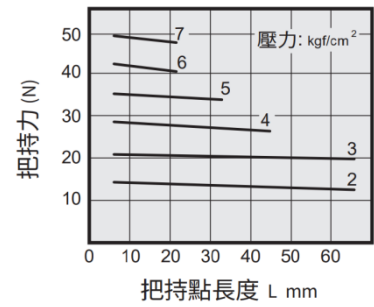

### ADZL-20

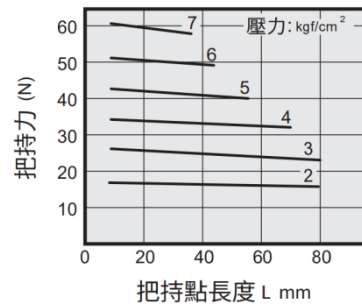

### ADZL-25

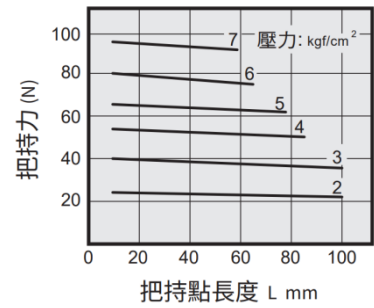

## 內徑夾持力特性圖

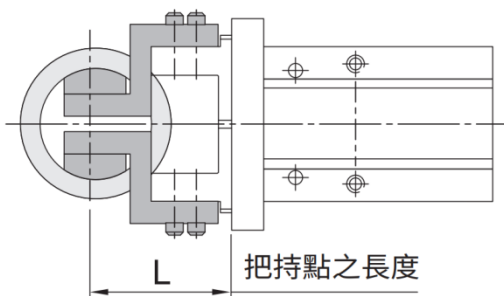

### ADZL-10

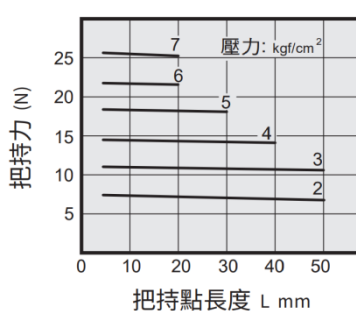

### ADZL-16

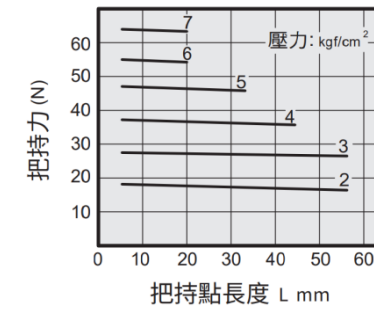

### ADZL-20

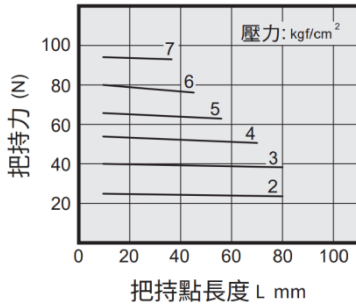

### ADZL-25

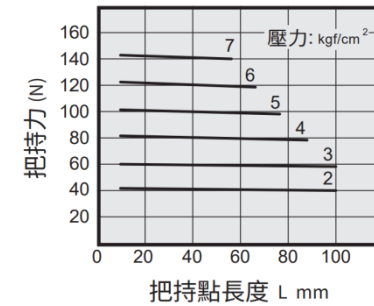



## 夾爪最大允許偏移量-外徑夾持

工件夾持請在允許範圍內使用，超出允許範圍對氣動夾爪的壽命會有不良影響。

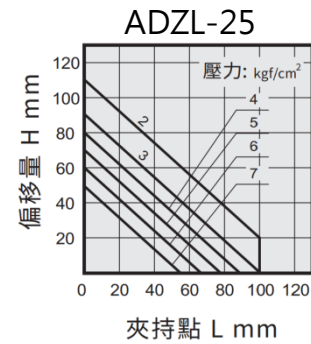
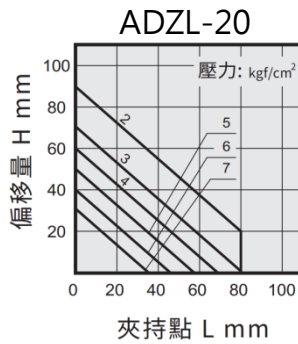
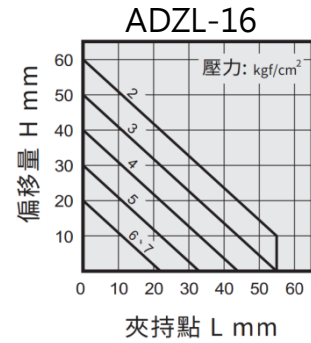
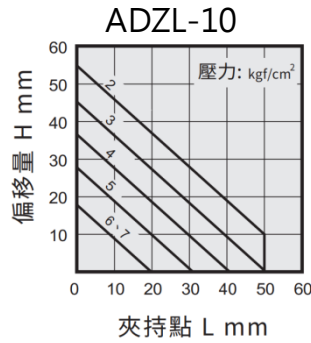
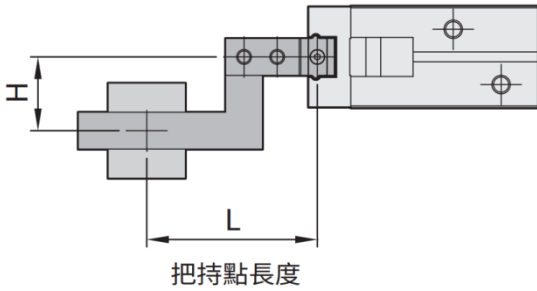

## 夾爪最大允許偏移量-內徑夾持

工件夾持請在允許範圍內使用，超出允許範圍對氣動夾爪的壽命會有不良影響。

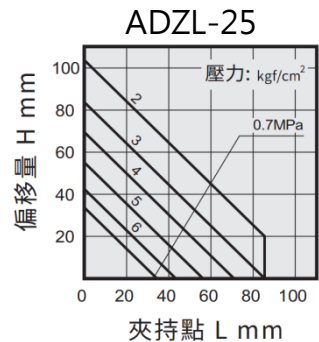
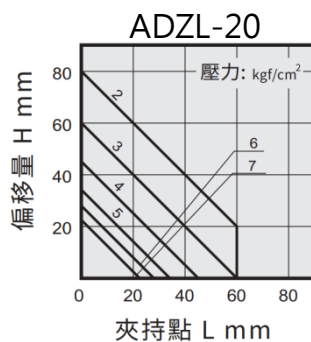
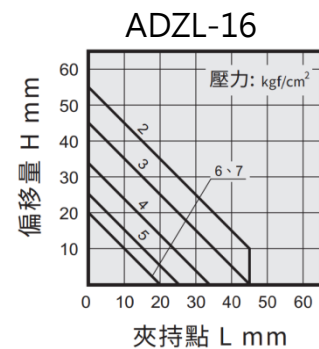
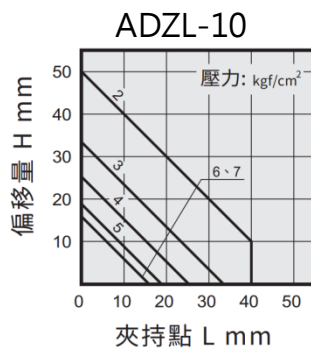
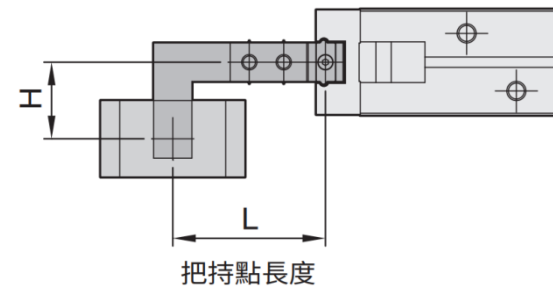



## 數據表

型號	最小動作壓力 kgf/cm <sup>2</sup>	氣爪上螺紋孔 mm	有效夾持力 N	
ADZL-10	2.2	4-M3 x 0.5P	開	17
			閉	11
ADZL-16	1.5	4-M3 x 0.5P	開	45
			閉	34
ADZL-20	1.5	4-M4 x 0.7P	開	66
			閉	42
ADZL-25	1.5	4-M5 x 0.8P	開	104
			閉	65

註：夾持力是在爪臂接點長度為 30mm，動作壓力為 5 kgf/cm<sup>2</sup> 時，開或關爪片產生的力。

## 外觀尺寸

### ■ ADZL-10

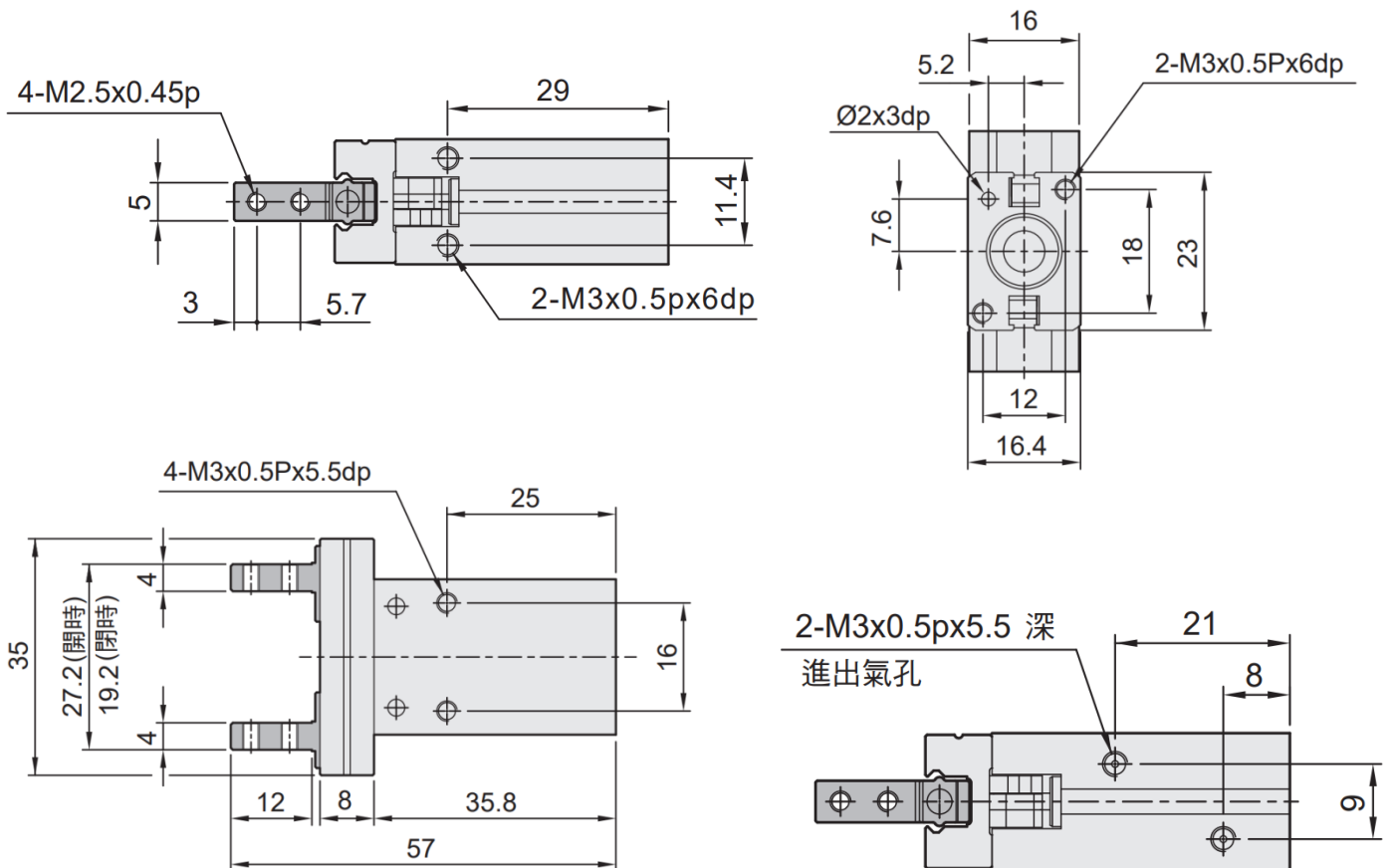



## ADZL-16

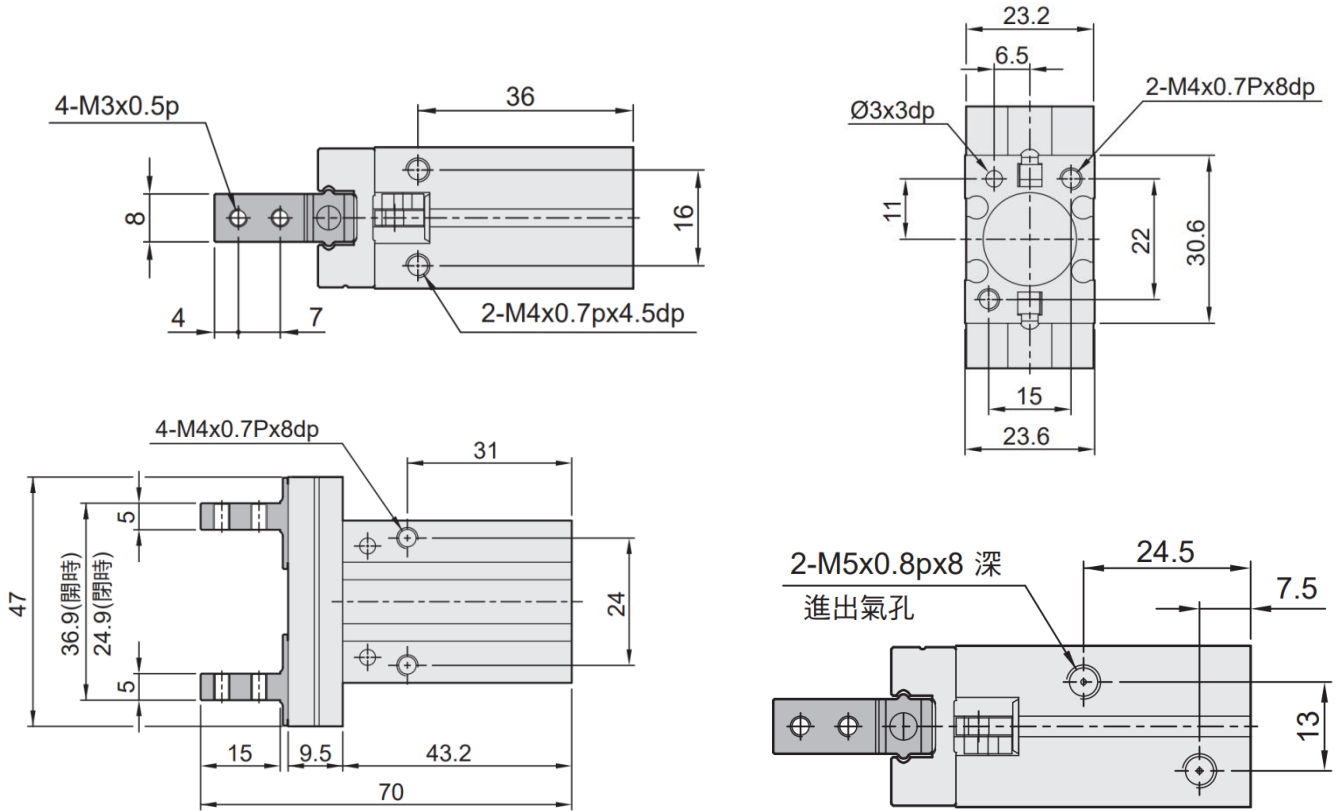

## ADZL-20

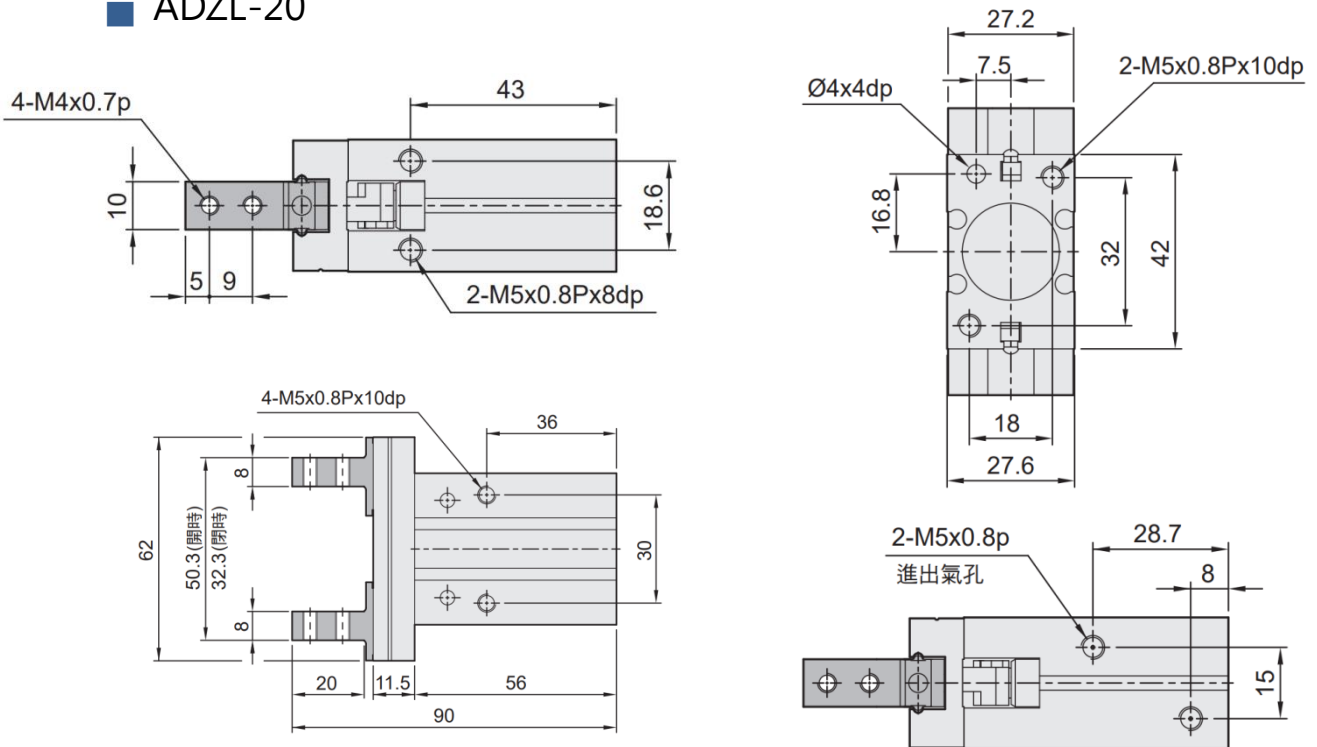



## ■ ADZL-25

