

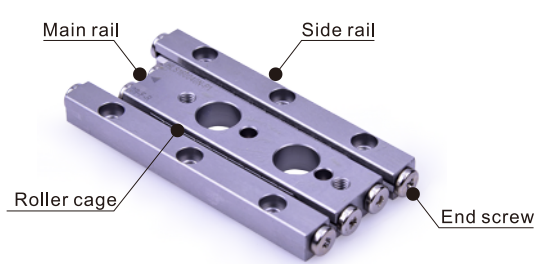

# LGC Series Crossed Roller Way

## Product Introduction

Crossed Roller provides high rigidity and high accuracy linear movement with non-recirculating rollers design. By cross-arrangement of rollers, it will hugely reduce friction meanwhile provide high rigidity for rollers to bear heavy loads. Crossed roller is mainly used in high precision machine and measurement equipment such as circuit board printer, optical measurement instrument, X-ray equipment or base for multiple kinds of instruments.



Three-Row Type Of Crossed Roller Way

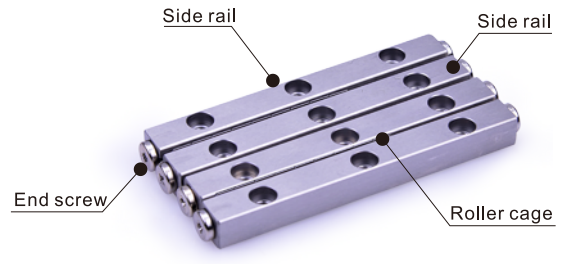

Four-Row Type Of Crossed Roller Way



Cylindrical roller with high precision roundness and wear resistance (JIS B 1506 G2) is manufactured in Japan

## Order Information

**LGC 3 A 200 R25 - H**

- ①
- ②
- ③
- ④
- ⑤
- ⑥



① <b>Model Code</b>	LGC : Crossed Roller Way
② <b>Roller Diameter</b>	1 : $\Phi$ 1.5mm    2 : $\Phi$ 2.0mm    3 : $\Phi$ 3.0mm    4 : $\Phi$ 4.0mm    6 : $\Phi$ 6.0mm
③ <b>Type [Note]</b>	A: Three-row type [Note]    B: Four-row type
④ <b>Rail dimension</b>	200: rail length    200X100: main rail length is 200mm/side rail length is 100mm [Reference to spec. table for detail]
⑤ <b>The number of rollers in each roller cage</b>	R25: 25 rollers ..... [Reference to spec. table for detail]
⑥ <b>Accuracy</b>	H : High    P : Precision

[Note] LGC6: only for type B.



### Cross Reference Table for Maximun Stroke & Roller numbers

LGC1		Numbers of rollers in one roller cage								
Max. Stroke (mm)	R6	R7	R8	R9	R10	R11	R13	R16	R19	
Shortest length of rails (mm)	20	12	7	-	-	-	-	-	-	-
	30	-	-	22	17	12	7	-	-	-
	40	-	-	-	-	-	27	17	-	-
	50	-	-	-	-	-	-	37	22	7
	60	-	-	-	-	-	-	-	42	27
	70	-	-	-	-	-	-	-	-	47
	80	-	-	-	-	-	-	-	-	67

The standard quantity of rollers

Alternative options of the quantity of rollers

LGC2		Numbers of rollers in one roller cage													
Max. Stroke (mm)	R6	R7	R8	R9	R10	R11	R13	R16	R19	R22	R25	R28	R32	R36	
Shortest length of rails (mm)	30	16	8	-	-	-	-	-	-	-	-	-	-	-	
	45	-	-	30	22	14	-	-	-	-	-	-	-	-	
	60	-	-	-	-	-	36	20	-	-	-	-	-	-	
	75	-	-	-	-	-	-	50	26	-	-	-	-	-	
	90	-	-	-	-	-	-	-	56	32	-	-	-	-	
	105	-	-	-	-	-	-	-	-	62	38	-	-	-	
	120	-	-	-	-	-	-	-	-	-	68	44	-	-	
	135	-	-	-	-	-	-	-	-	-	98	74	50	-	
	150	-	-	-	-	-	-	-	-	-	-	104	80	48	
	165	-	-	-	-	-	-	-	-	-	-	-	110	78	45
180	-	-	-	-	-	-	-	-	-	-	-	-	140	108	76

LGC3		Numbers of rollers in one roller cage														
Max. Stroke (mm)	R7	R8	R9	R10	R11	R13	R16	R19	R22	R25	R28	R32	R36	R40		
Shortest length of rails (mm)	50	34	24	14	-	-	-	-	-	-	-	-	-	-		
	75	-	-	-	54	44	24	-	-	-	-	-	-	-		
	100	-	-	-	-	74	44	-	-	-	-	-	-	-		
	125	-	-	-	-	-	94	64	-	-	-	-	-	-		
	150	-	-	-	-	-	-	114	84	54	-	-	-	-		
	175	-	-	-	-	-	-	-	134	104	74	-	-	-		
	200	-	-	-	-	-	-	-	-	154	124	84	-	-		
	225	-	-	-	-	-	-	-	-	-	-	174	134	94		
	250	-	-	-	-	-	-	-	-	-	-	-	184	144	104	
	275	-	-	-	-	-	-	-	-	-	-	-	-	234	194	154
	300	-	-	-	-	-	-	-	-	-	-	-	-	-	244	204

LGC4		Numbers of rollers in one roller cage															
Max. Stroke (mm)	R8	R9	R10	R11	R13	R16	R19	R22	R25	R28	R32	R36	R40	R45			
Shortest length of rails (mm)	80	54	40	26	-	-	-	-	-	-	-	-	-	-			
	120	-	-	-	92	64	-	-	-	-	-	-	-	-			
	160	-	-	-	-	-	102	60	-	-	-	-	-	-			
	200	-	-	-	-	-	-	140	98	56	-	-	-	-			
	240	-	-	-	-	-	-	-	178	136	94	-	-	-			
	280	-	-	-	-	-	-	-	-	216	174	118	-	-			
	320	-	-	-	-	-	-	-	-	-	254	198	142	86			
	360	-	-	-	-	-	-	-	-	-	-	278	222	166	96		
	400	-	-	-	-	-	-	-	-	-	-	-	358	302	246	176	
	440	-	-	-	-	-	-	-	-	-	-	-	-	-	382	326	256
	480	-	-	-	-	-	-	-	-	-	-	-	-	-	-	406	336

LGC6		Numbers of rollers in one roller cage													
Max. Stroke (mm)	R8	R9	R11	R13	R16	R19	R22	R25	R28	R32	R36	R40	R45		
Shortest length of rails (mm)	100	62	44	-	-	-	-	-	-	-	-	-	-		
	150	-	-	108	72	-	-	-	-	-	-	-	-		
	200	-	-	-	-	118	64	-	-	-	-	-	-		
	250	-	-	-	-	-	164	110	56	-	-	-	-		
	300	-	-	-	-	-	-	210	156	102	-	-	-		
	350	-	-	-	-	-	-	-	256	202	130	-	-		
	400	-	-	-	-	-	-	-	-	302	230	158	-		
	450	-	-	-	-	-	-	-	-	-	330	258	186		
	500	-	-	-	-	-	-	-	-	-	-	358	286	196	
	550	-	-	-	-	-	-	-	-	-	-	-	458	386	296
	600	-	-	-	-	-	-	-	-	-	-	-	-	486	396

### Accuracy

#### Accuracy

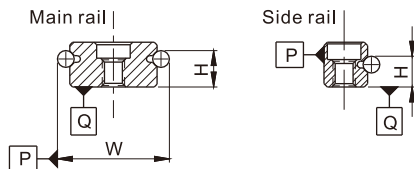

Unit : mm

Item	High(H)	Precision(P)
Tolerance of height H	±0.02	±0.01
Variation of height H	0.01	0.005
Tolerance of width W	±0.02	±0.01

#### Rail Length and Parallelism of The Raceway

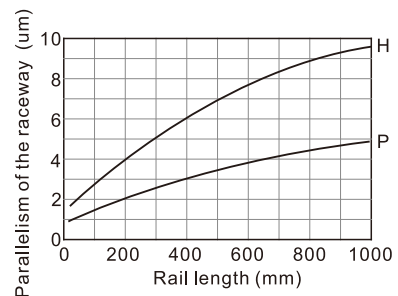

### Specification Table

#### Dimensions of Three-row Type

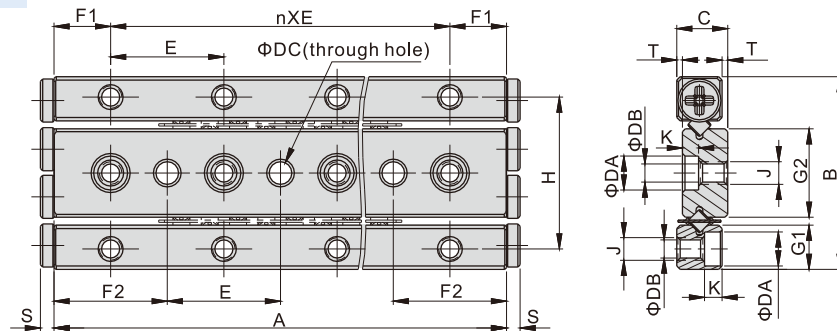

Model/Item	A	B	C	ΦDA	ΦDB	ΦDC	nXE	F1	F2	G1	G2	H	J	K	S	T
LGC1A20	20	17	4.5	3.0	1.55	$2^{+0.03}_{+0.005}$	1X10	5	10	3.9	7.8	13.4	M2X0.4	1.5	1.2	0.5
LGC1A30	30						2X10									
LGC1A40	40						3X10									
LGC1A50	50						4X10									
LGC1A60	60						5X10									
LGC1A70	70						6X10									
LGC1A80	80						7X10									
LGC2A30	30	24	6.5	4.4	2.5	$3^{+0.03}_{+0.005}$	1X15	7.5	15	5.5	11	19	M3X0.5	2.1	1.5	0.5
LGC2A45	45						2X15									
LGC2A60	60						3X15									
LGC2A75	75						4X15									
LGC2A90	90						5X15									
LGC2A105	105						6X15									
LGC2A120	120						7X15									
LGC2A135	135						8X15									
LGC2A150	150						9X15									
LGC2A165	165						10X15									
LGC2A180	180						11X15									
LGC3A50	50	36	8.5	6.0	3.4	$4^{+0.03}_{+0.005}$	1X25	12.5	25	8.3	16.6	29	M4X0.7	3.1	2	0.5
LGC3A75	75						2X25									
LGC3A100	100						3X25									
LGC3A125	125						4X25									
LGC3A150	150						5X25									
LGC3A175	175						6X25									
LGC3A200	200						7X25									
LGC3A225	225						8X25									
LGC3A250	250						9X25									
LGC3A275	275						10X25									
LGC3A300	300						11X25									
LGC4A80	80	44	11.5	7.5	4.3	$5^{+0.03}_{+0.005}$	1X40	20	40	10	20	35	M5X0.8	4.1	2	0.5
LGC4A120	120						2X40									
LGC4A160	160						3X40									
LGC4A200	200						4X40									
LGC4A240	240						5X40									
LGC4A280	280						6X40									
LGC4A320	320						7X40									
LGC4A360	360						8X40									
LGC4A400	400						9X40									
LGC4A440	440						10X40									
LGC4A480	480						11X40									

[Note] One set includes one main rail, two side rails, two roller cages, and the corresponding screws for mounting.

### Specification Table

#### Dimensions of Four-row Type

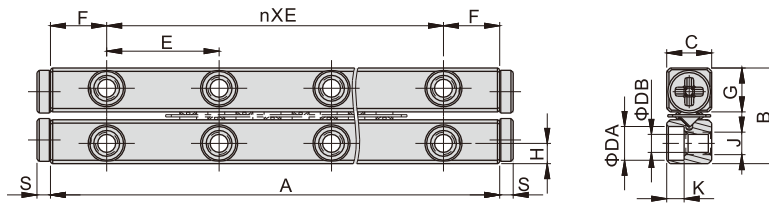

Model/Item	A	B	C	ΦDA	ΦDB	nXE	F	G	H	J	K	S
LGC1B20	20	8.5	4	3.0	1.55	1X10	5	3.9	1.8	M2X0.4	1.5	1.2
LGC1B30	30					2X10						
LGC1B40	40					3X10						
LGC1B50	50					4X10						
LGC1B60	60					5X10						
LGC1B70	70					6X10						
LGC1B80	80					7X10						
LGC2B30	30					12						
LGC2B45	45	2X15										
LGC2B60	60	3X15										
LGC2B75	75	4X15										
LGC2B90	90	5X15										
LGC2B105	105	6X15										
LGC2B120	120	7X15										
LGC2B135	135	8X15										
LGC2B150	150	9X15										
LGC2B165	165	10X15										
LGC2B180	180	11X15										
LGC3B50	50	18	8	6.0	3.4	1X25	12.5	8.3	3.5	M4X0.7	3.1	2
LGC3B75	75					2X25						
LGC3B100	100					3X25						
LGC3B125	125					4X25						
LGC3B150	150					5X25						
LGC3B175	175					6X25						
LGC3B200	200					7X25						
LGC3B225	225					8X25						
LGC3B250	250					9X25						
LGC3B275	275					10X25						
LGC3B300	300					11X25						
LGC4B80	80	22	11	7.5	4.3	1X40	20	10	4.5	M5X0.8	4.1	2
LGC4B120	120					2X40						
LGC4B160	160					3X40						
LGC4B200	200					4X40						
LGC4B240	240					5X40						
LGC4B280	280					6X40						
LGC4B320	320					7X40						
LGC4B360	360					8X40						
LGC4B400	400					9X40						
LGC4B440	440					10X40						
LGC4B480	480					11X40						
LGC6B100	100	31	15	9	5.3	1X50	25	14.7	6	M6X1.0	5.2	3
LGC6B150	150					2X50						
LGC6B200	200					3X50						
LGC6B250	250					4X50						
LGC6B300	300					5X50						
LGC6B350	350					6X50						
LGC6B400	400					7X50						
LGC6B450	450					8X50						
LGC6B500	500					9X50						
LGC6B550	550					10X50						
LGC6B600	600					11X50						

[Note] One set includes four side rails, two roller cages, and the corresponding screws for mounting.

### Roller Cage Order Information

#### LGC 3 R25

① ② ③



① Model Code	LGC : Crossed Roller Way
② Roller Diameter	1 : $\Phi$ 1.5mm 2 : $\Phi$ 2.0mm 3 : $\Phi$ 3.0mm 4 : $\Phi$ 4.0mm 6 : $\Phi$ 6.0mm
③ The number of rollers	R25:25 rollers .... [Reference to spec. table for detail]

### Specification Table

#### Informations of Roller Cage

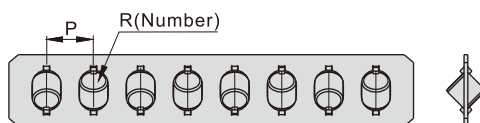

Model\Item	P	R	Basic Dynamic Load Rating (C <sub>d</sub> )	Basic Static Load Rating (C <sub>s</sub> )	Allowable Load (F <sub>0</sub> )	Model\Item	P	R	Basic Dynamic Load Rating (C <sub>d</sub> )	Basic Static Load Rating (C <sub>s</sub> )	Allowable Load (F <sub>0</sub> )
LGC1R6	2.5	6	125N per roller	120N per roller	39N per roller	LGC4R8	7	8	1230N per roller	1170N per roller	390N per roller
LGC1R7		7				LGC4R9		9			
LGC1R8		8				LGC4R10		10			
LGC1R9		9				LGC4R11		11			
LGC1R10		10				LGC4R13		13			
LGC1R11		11				LGC4R16		16			
LGC1R13		13				LGC4R19		19			
LGC1R16		16				LGC4R22		22			
LGC1R19		19				LGC4R25		25			
LGC2R6	4	6	292N per roller	290N per roller	97N per roller	LGC4R28	9	28	3175N per roller	2550N per roller	810N per roller
LGC2R7		7				LGC4R32		32			
LGC2R8		8				LGC4R36		36			
LGC2R9		9				LGC4R40		40			
LGC2R10		10				LGC4R45		45			
LGC2R11		11				LGC6R8		8			
LGC2R13		13				LGC6R9		9			
LGC2R16		16				LGC6R11		11			
LGC2R19		19				LGC6R13		13			
LGC2R22		22				LGC6R16		16			
LGC2R25		25				LGC6R19		19			
LGC2R28		28				LGC6R22		22			
LGC2R32		32				LGC6R25		25			
LGC2R36	36	LGC6R28	28								
LGC3R7	5	7	640N per roller	610N per roller	203N per roller	LGC6R32	9	32	3175N per roller	2550N per roller	810N per roller
LGC3R8		8				LGC6R36		36			
LGC3R9		9				LGC6R40		40			
LGC3R10		10				LGC6R45		45			
LGC3R11		11									
LGC3R13		13									
LGC3R16		16									
LGC3R19		19									
LGC3R22		22									
LGC3R25		25									
LGC3R28		28									
LGC3R32		32									
LGC3R36		36									
LGC3R40		40									

### User Manual

#### Load Rating

Load direction	Vertical load		Lateral load	
Type	Three-Row type	Four-Row type	Three-Row type	Four-Row type
Schematic				
Basic dynamic load rating - $C_a$ (N)	$C_a = \{2P \times (\frac{R}{2} - 1)\}^{\frac{1}{36}} \times (\frac{R}{2})^{\frac{3}{4}} \times C_1$ * Effective roller number $R/2$ : round off to integer (EX : $5/2=2.5$ , take 2)		$C_a = \{2P \times (\frac{R}{2} - 1)\}^{\frac{1}{36}} \times (\frac{R}{2})^{\frac{3}{4}} \times 2^{\frac{7}{9}} \times C_1$ * Effective roller number $R/2$ : round off to integer (EX : $5/2=2.5$ , take 2)	
Basic Static load rating - $C_{a0}$ (N)	$C_{a0} = R \times C_0$		$C_{a0} = R \times C_0$	
Allowable load - $F_{a0}$ (N)	$F_{a0} = R \times F_0$		$F_{a0} = R \times F_0$	

P: Pitch of roller cage (mm)  
 R: The number of cylindrical rollers incorporated in a roller cage  
 $C_1$ : Basic dynamic load rating per cylindrical roller (N)  
 $C_0$ : Basic static load rating per cylindrical roller (N)  
 $F_0$ : Allowable load per cylindrical roller (N)

Ex : Calculate LGC3A180R25 basic load rating  
 From specification table (Informations of Roller Cage)  
 Pitch of roller cage :  $P=5\text{mm}$   
 The number of cylindrical rollers incorporated in a roller cage :  $R = 25$   
 Basic dynamic load rating per cylindrical roller :  $C_1 = 640\text{N}$   
 Basic static load rating per cylindrical roller :  $C_0 = 610\text{N}$   
 Allowable load per cylindrical roller :  $F_0 = 203\text{N}$   
 Effective roller number  $R/2 = 12.5$ , take 12  
 Take these parameters into calculation, we can get  
 For vertical load : Basic dynamic load rating  $C_a = 4,701.88\text{N}$  ;  
 Basic Static load rating  $C_{a0} = 15,250\text{N}$  ;  
 Allowable load  $F_{a0} = 5,075\text{N}$  ;  
 For Lateral load : Basic dynamic load rating  $C_a = 8,061.31\text{N}$  ;  
 Basic Static load rating  $C_{a0} = 15,250\text{N}$  ;  
 Allowable load  $F_{a0} = 5,075\text{N}$  .

#### Static Safety Factor( $f_s$ )

Inertia force caused by impact, sudden start or stop will exert unexpected force on crossed roller guide. Therefore, safety factor based on working condition needs to be put into consideration, see as follows:

Load Condition	$f_s$
Normal Load	1.0~1.3
Load with Impacts or Vibrations	2.0~3.0

$$f_s = \frac{C_{a0}}{F}$$

$f_s$ : Static safety factor  
 $C_{a0}$ : Basic static load rating (N)  
 $F$ : Calculated working load (N)

#### Nominal Life(L)

Nominal life is calculated as follow:

$$L = \left(\frac{f_t}{f_w} \cdot \frac{C_a}{F}\right)^{\frac{10}{3}} \times 100$$

L: Nominal life (km)  
 $C_a$ : Basic dynamic load rating (N)  
 $F$ : Calculated working load (N)  
 $f_t$ : Temperature factor (Reference to Temperature Factor Chart)  
 $f_w$ : Load factor (Reference to Load Factor Table)

#### Calculating the Service Life Time( $L_n$ )

Based on the calculated nominal life, the Service Life Time is obtained through the following equation as if the stroke length and the value of reciprocations per minutes remain constant.

$$L_n = \frac{L \times 10^6}{2 \times \ell_s \times m \times 60}$$

$L_n$ : Service life time (h)  
 $\ell_s$ : Stroke length (mm)  
 $m$ : Rounds per minute ( $\text{min}^{-1}$ )

#### Temperature Factor( $f_t$ )

If the environmental temperature exceeds  $100^\circ\text{C}$ , take the adverse effect of the high temperature into account by multiplying the basic load ratings by the temperature factor.

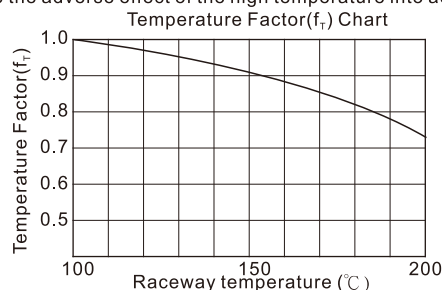

## LGC Series

### Load Factor( $f_w$ )

In general, reciprocating machines tend to involve vibrations or impact during operation. It is extremely difficult to accurately determine the impact caused by high-speed motion or frequent start and stop motion. However, the calibrated load can be expected by experience. The basic load rating( $C_o$  or  $C_{so}$ ) divide by load factor( $f_w$ ) in the following table to calibrate from speed effect and vibrations.

Load Factor Table		
Vibrations/Impact	Speed(V)	$f_w$
Faint	$V \leq 0.25\text{m/s}$	1~1.2
Weak	$0.25 < V \leq 1\text{m/s}$	1.2~1.5

### Stroke

When moving, roller cage will move along with rail about half of its moving distance. Therefore, distance between center of loads and roller cage will vary with motion. In order to maintain accuracy, please conform to 'Cross Reference Table for Max. Stroke & Roller Numbers' table when deciding specs.

EX: Choose spec for a roller diameter 6 mm, high accuracy type and desiring length of rails are 300 and 200 mm, desiring moving distance is 50 mm.

Refer to 'Cross Reference Table for Max. Stroke & Roller Numbers': roller diameter 6 mm with 200 mm as shortest rail, its roller numbers can be R16 or R19, and admissible moving distance is 118 and 64 mm respectively.

Both roller numbers can meet the required working distance 50mm.

### Mounting Screw

Tightening torque for fixing screw

Spec	Screw size	Tightening torque(N.m)
LGC1	M1.4X0.3PX6L	0.14
LGC2	M2.0X0.4PX8L	0.40
LGC3	M3.0X0.5PX9.5L	1.40
LGC4	M4.0X0.7PX16L	3.20
LGC6	M5.0X0.8PX20L	6.60

※High strength screw is preferred.

### Adjusting Screw

Tightening torque for fixing screw

Spec	Screw size	Tightening torque(N.m)
LGC1	M2	0.008
LGC2	M3	0.012
LGC3	M4	0.05
LGC4	M4	0.08
LGC6	M5	0.2

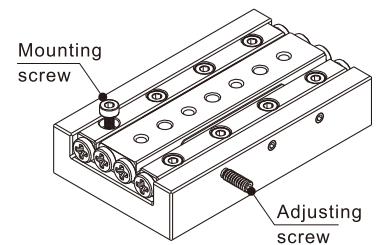

## Precautions on use

### 1. Caution in handling

Dropping crossed roller way may cause damage on surface and further affect its accuracy, and even jerks during movement.

### 2. Adjustment

Fail to adjust the preload or mounting surfaces correctly will affect the product lifetime and accuracy. Make sure to assemble, install, and adjust the product with care. Appropriate preload will help with rigidity and accuracy; yet overloading the crossed roller way will result in damages and deformation. On installation, please follow the installation procedure and recommended torque.

### 3. Use as a Set

The accuracy of crossed roller guide is controlled as a set. Accuracy is not guaranteed when mixing parts from different sets.

### 4. Allowable Load

Definition of allowable load is the maximum loads applied on crossed roller to cause acceptable elastic deformation while maintain a smooth movement. When working condition requires high accuracy and smooth movement, be sure load applied on product is under allowable load.

### 5. Cage Slippage

The roller cage could slip under high speed motion, vertical use application, unbalanced load, and vibration conditions.

Avoiding excessive loads is recommended. Meanwhile, using crossed roller within range of allowable stroke while applying safety factors will help avoid compression and damage.